

# Double Swivel Rings

male

## Lifting Bolts & Shackles

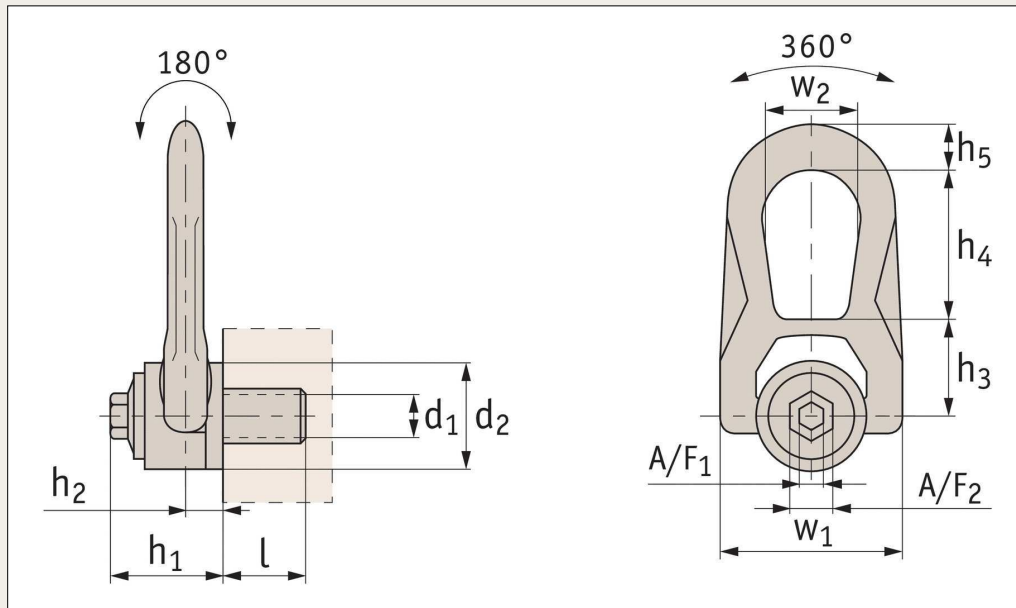

### P4005

#### Material

High tensile steel, strength class >8.  
Supplied with CE certificate.

#### Technical notes

Double articulation.  
Very low overhang for improved safety.  
Large support surface.  
Longer or shorter thread lengths can be supplied but please consult our technical department for this information if required.  
For use in temperatures from -20°C to +200°C. Can be used in lower or

higher temperatures but this affects the load rating - please ask for more information.  
Please refer to our technical information pages when specifying and/or using.

#### Tips

Double articulation allows perfect alignment with the sling if the part rotates during the lift.  
With "automatic" position recovery system for best orientation to sling direction.  
Tighten by hex. key or spanner.

#### Important notes

The thread diameter and depth must be appropriate to the material into which it will be installed:  
Steel (min. ST37) - 1 x thread dia.  
Cast iron - 1.25 x thread dia.  
Aluminium - 2 x thread dia.  
Other light metals - 2.5 x thread dia.  
Tolerance of female thread to be 6H (metric) or UNC-2B (inch).  
**Please refer to the safety documentation before using this part.**  
**Supplied with certificate and operating instructions.**

Order No.	Max. load tons (lbs)	d <sub>1</sub> tol. 6g (tol. 2A)	l	w <sub>1</sub>	h <sub>1</sub>	h <sub>2</sub>	h <sub>3</sub>	h <sub>4</sub>	h <sub>5</sub>	d <sub>2</sub>	w <sub>2</sub>	A/F <sub>1</sub>	A/F <sub>2</sub>	Safety factor	Torque to Nm (ft lbs)	Δ <sup>±</sup> Kg
P4005.M004	0,05	M 4x 0,70	15	53	33	9,5	30	38	14	30	27	3	-	5	2	0,3
P4005.M005	0,07	M 5x 0,80	15	53	33	9,5	30	38	14	30	27	4	-	5	3	0,3
P4005.M006	0,10	M 6x 1,00	15	53	33	9,5	30	38	14	30	27	5	-	5	4	0,3
P4005.M008	0,30	M 8x 1,25	14	53	33	9,5	30	38	14	30	27	8	16	5	6	0,3
P4005.M010	0,60	M10x1,50	17	53	33	9,5	30	38	14	30	27	8	16	5	10	0,3
P4005.M012	1,00	M12x1,75	21	53	33	9,5	30	38	14	30	27	8	16	5	15	0,3
P4005.M014	1,30	M14x2,00	23	76	45	13	42	54	17	45	38	8	20	5	30	0,9
P4005.M016	1,60	M16x2,00	27	76	45	13	42	54	17	45	38	8	20	5	50	0,9
P4005.M018	2,00	M18x2,50	27	76	45	13	42	54	17	45	38	8	20	5	70	0,9
P4005.M020	2,50	M20x2,50	30	76	45	13	42	54	17	45	38	8	20	5	100	0,9
P4005.M022	3,00	M22x2,50	33	117	62	19	55	83	25	60	55	14	24	5	120	2,6
P4005.M024	4,00	M24x3,00	36	117	62	19	55	83	25	60	55	14	24	5	160	2,6
P4005.M027	5,00	M27x3,00	40	117	62	19	55	83	25	60	55	14	24	5	200	2,7
P4005.M030	6,30	M30x3,50	45	117	62	19	55	83	25	60	55	14	24	5	250	2,7
P4005.I031	(650)	(UNC 5/16"-18)	15	53	33	9,5	30	38	14	30	27	5/16"	5/8"	5	(7)	0,3
P4005.I037	(1,200)	(UNC 3/8"-16)	17	53	33	9,5	30	38	14	30	27	5/16"	5/8"	5	(8)	0,3
P4005.I050	(2,200)	(UNC 1/2"-13)	21	53	33	9,5	30	38	14	30	27	5/16"	5/8"	5	(12)	0,3
P4005.I063	(3,800)	(UNC 5/8"-11)	24	76	45	13	42	54	17	45	38	5/16"	20	5	(40)	0,9

Tel: 01483 26 67 74  
Fax: 01483 26 67 75

Email: info@automotioncomponents.co.uk  
Web: automotioncomponents.co.uk

**AUTOMOTION®**  
**COMPONENTS**

# Double Swivel Rings

male

Lifting Bolts & Shackles

Order No.	Max. load tons (lbs)	d <sub>1</sub> tol. 6g (tol. 2A)	l	w <sub>1</sub>	h <sub>1</sub>	h <sub>2</sub>	h <sub>3</sub>	h <sub>4</sub>	h <sub>5</sub>	d <sub>2</sub>	w <sub>2</sub>	A/F <sub>1</sub>	A/F <sub>2</sub>	Safety factor	Torque to Nm (ft lbs)	 Kg
<b>P4005.I075</b>	(5,500)	(UNC 3/4"-10)	30	76	45	13	42	54	17	45	38	5/16"	20	5	(80)	0,9
<b>P4005.I088</b>	(6,600)	(UNC 7/8"-9)	33	117	62	19	55	83	25	60	55	9/16"	24	5	(100)	2,5
<b>P4005.I100</b>	(10,000)	(UNC 1"-8)	36	107	62	19	55	83	25	60	55	9/16"	24	5	(125)	2,6

# AUTOMOTION<sup>®</sup>

---

# COMPONENTS

## Lifting Bolts Safety Guide





**Single swivel**

Threads M8 – M48  
Loads 0,3 tons  
to 15 tons



**Double swivel**

Threads M4 – M100  
Loads 0,05 tons  
to 50 tons



**Triple swivel**

Threads M8 – M56  
Loads 0,3 tons  
to 22 tons

**Introduction to swivel lifting rings and Lifting Bolts**

Our swivel lifting rings fully comply with the EC directive 2006/42/EC. They are CE marked and are supplied with a Certificate of Conformity. There is a 100% check on anti-cracking, a proof load test of 2.5 x load limit and a safety factor of 5 on most parts. Each ring is individually marked to ensure full product traceability.

The Swivel Lifting Rings come in three main forms – depending on the number of axis required to swivel. The most popular type is the double swivel rings.

**Other Standard Lifting Bolts**

**Standard lifting bolts (to DIN 580 and DIN 582)**

These are CE marked and are available with male or female threads in either steel or stainless steel (A4 AISI 316). They are meant only for linear loading of the bolts at a maximum angle of 45° from the thread. They are not meant for loads that might swivel.

These are supplied with a generic CE Certificate of Conformity stating that the parts have been manufactured to the relevant DIN standard and therefore suitable for lifting.

**High-tensile lifting bolts**

The High-tensile lifting bolts are similar to the standard lifting bolts but are rated at higher loads and can lift loads at up to 90° from the thread. They are not meant for loads that might swivel.



**Standard lifting bolts**

DIN 580 & DIN 582

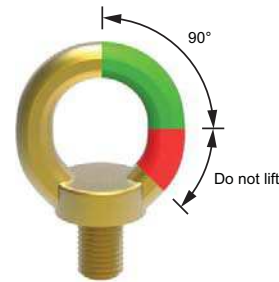

**Hi-tensile lifting bolts**

**Swivel lifting rings operating instructions.**

**Please follow these instructions carefully.**

- Ensure all lifting bolts are CE marked.
- Ensure they are handled by qualified personnel.
- Refer to the operating instructions particularly with regards to product selection, any possibility of the load swivelling, the effect of lifting angles on the load capacity (see relevant tables), etc.
- Never allow any personnel underneath a suspended load.
- Always heed the load rating of the lifting bolt.
- Always perform a visual inspection of the lifting rings prior to use. Checking for any damage to thread and/or swivelling system. Check for wear or corrosion, signs of stress or bending. Check CE mark and load rating.
- Ensure a yearly full service inspection is performed.
- Always ensure the full bottom face of the lifting bolts is in contact with a smooth, square surface.
- Ensure bolt is tightened to the correct torque.
- Ensure full and unrestricted movement of the lifting ring in all directions.
- Before each lift ensure the correct orientation of the shackle in the lift direction.
- Avoid using our standard steel lifting rings in corrosive environments eg sandy, chemical, acid, moisture etc. In this case consider using our stainless steel lifting rings.
- Note the thread length requirements:
  - 1 x thread diameter for steel (ST37 min.).
  - 1.25 x thread diameter for cast iron.
  - 2 x thread diameter for aluminium.
  - 2.5 x thread diameter for other light metals.
  - If fixing into low resistance material it is better to allow for a bigger diameter thread to compensate for the lower material resistance.

Note: The full thread must be engaged. Longer thread lengths can be supplied on request or a bolt and washer/nut combination can be used.



**Temperature extremes**

- 40°C to -20°C Load rating reduces by 20%.
- +200°C to +300°C Load rating reduces by 10%.
- +300°C to +400°C Load rating reduces by 25%.

**Rugged**

For harsh environments we recommend the use of our stainless steel lifting rings.

**P4020**

Threads M8 – M30  
Loads 0,3 tons to 3 tons.



**P4022**

Threads M30 – M45  
Loads 3,5 tons to 6 tons.



**Product marking**

Compliant with 2006/42/EC, and with individual date of manufacture and batch number.

Complies with 2006/42/CE



**Installation Information**

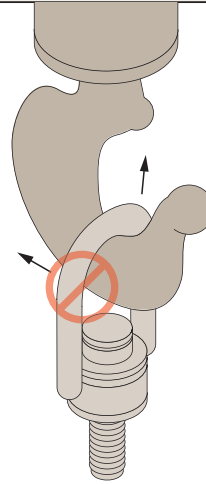

**Never** use an oversized hook or other lifting device which will pry or tend to open the "U" shaped bar on center pull hoist rings.

**Lifting angles**

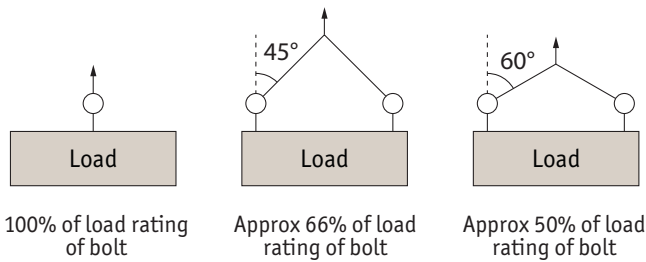

For full information on lifting arrangements see technical pages

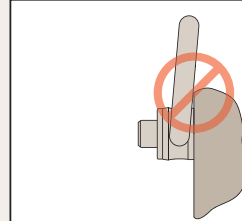

After installation, check the hoist ring to be sure it swivels and pivots freely in all directions. **The side of the ring must not contact anything.**

**Steel and Stainless steel (316) versions**



Steel



Stainless (316L)

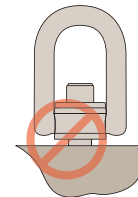

**Always** ensure full thread engagement when installing hoist rings. Also ensure face is flush.



**P4002 + P4004**

Units - Tons	No. of rings	Lifting angle										
			M8	M10	M12	M16	M20	M24	M30	M36	M42	M48
	1	0°	0,3	0,6	1	1,6	2,5	4	6,3	10	12,5	15
	2	0°	0,6	1,2	2	3,2	5	8	12,6	20	25	30
	1	90°	0,3	0,6	1	1,6	2,5	4	6,3	10	12,5	15
	2	90°	0,6	1,2	2	3,2	5	8	12,6	20	25	30
 $\alpha$ max. = 60°	2	0°	0,4	0,8	1,4	2,2	3,5	5,6	8,8	14	17,5	21
		45°										
	46°	2	-	0,3	0,6	1	1,6	2,5	4	6,3	10	12,5
 $\alpha$ max. = 60°	3 - 4	0°	0,6	1,3	2,1	3,4	5,3	8,4	13,2	21	26,3	31,5
		45°										
	46°	3 - 4	-	0,3	0,6	1	1,6	2,5	4	6,3	10	12,5







**P4005 +P4006**



**P4008 +P4010**

M8	M10	M12	M16	M20	M24	M30	M30	M36	M42	M48	M56	M64
0,3	0,6	1	1,6	2,5	4	6,3	7,3	10	12,5	20	25	32.1
0,6	1,2	2	3,2	5	8	12,6	14,6	20	25	40	50	64,2
0,3	0,6	1	1,6	2,5	4	6,3	7,3	10	12,5	20	25	32,1
0,6	1,2	2	3,2	5	8	12,6	14,6	20	25	40	50	64,2
0,4	0,8	1,4	2,2	3,5	5,6	8,8	10,2	14	17,5	28	35	44,9
0,3	0,6	1	1,6	2,5	4	6,3	7,3	10	12,5	20	25	32.1
0,6	1,3	2,1	3,4	5,3	8,4	13,2	15,3	21	26,3	42	52,5	67,4
0,3	0,6	1	1,6	2,5	4	6,3	7,3	10	12,5	20	25	32.1

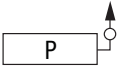
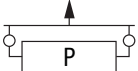
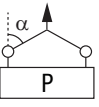
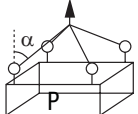
Units - Tons	No. of rings	Lifting angle	 <b>P4011</b>				 <b>P4015</b>								
			M72	M80	M90	M100	M8	M10	M12	M16	M20	M24	M30	M36	
Lifting type															
	1	0°	35	40	45	50	0,3	0,6	1	1,6	2,5	4	6,3	10	
	2	0°	70	80	90	100	0,6	1,2	2	3,2	5	8	12,6	20	
	1	90°	35	40	45	50	0,3	0,6	1	1,6	2,5	4	6,3	10	
	2	90°	70	80	90	100	0,6	1,2	2	3,2	5	8	12,6	20	
 $\alpha$ max. = 60°	2	0°	49	56	63	70	0,4	0,8	1,4	2,2	3,5	5,6	8,8	14	
		45°													
	2	46°	35	40	45	50	0,3	0,6	1	1,6	2,5	4	6,3	10	
 $\alpha$ max. = 60°	3 - 4	0°	74	84	95	105	0,6	1,3	2,1	3,4	5,3	8,4	13,2	21	
		45°													
	3 - 4	46°	35	40	45	50	0,3	0,6	1	1,6	2,5	4	6,3	10	

**01483 26 67 74**





**P4015**



**P4020 + P4021**



**P4022 + P4023**

M42	M48	M56	M8	M10	M12	M16	M20	M24	M30	M30	M36	M42	M45
12,5	20	22	0,3	0,5	0,8	1,5	1,6	2,7	3	3,5	5	6	6
25	40	44	0,6	1	1,6	3	3,2	5,4	6	7	10	12	12
12,5	20	22	0,3	0,5	0,8	1,5	1,6	2,7	3	3,5	5	6	6
25	40	44	0,6	1	1,6	3	3,2	5,4	6	7	10	12	12
17,5	28	30,8	0,4	0,7	1,1	2,1	2,2	3,8	4,2	4,9	7	8,4	8,4
12,5	20	22	0,3	0,5	0,8	1,5	1,6	2,7	3	3,5	5	6	6
26,3	42	46,2	0,6	1,1	1,7	3,2	3,4	5,7	6,3	7,3	10,5	12,6	12,6
12,5	20	22	0,3	0,5	0,8	1,5	1,6	2,7	3	3,5	5	6	6

# AUTOMOTION® COMPONENTS

## PRODUCT DESCRIPTION

The following instructions apply to all swivel lifting rings manufactured or supplied by Automotion Components. These rings are listed and described in our technical catalogue. Only the official Automotion components catalogue can be used as a benchmark.

## QUALITY CERTIFICATION

All swivel lifting rings are manufactured in accordance with European standard EN 1677-1 and machinery directive 2006/42/CE. All products are supplied with a certificate of conformance, checked for anti-cracking and proof of load test (WLL x 2.5) according to current European standards. A safety factor of 5 is applicable to most products (see Automotion Components catalogue). Optional certification by an external certification company is available.

## MAXIMUM TRACEABILITY GUARANTEED

Individual tracking code on each ring. Manufacturing marking on each ring.

## USE TERMS

These products should only be used by competent personnel who are familiar with their use, who have been trained in accordance with current European standards. Personnel should not operate under suspended loads and should avoid actions which give rise to shocks, tugs or vibrations. The engraved WLL on these products must be adhered to at all times. The thread (diameter/length) must be applicable to the material in which it will be fitted. The following values should be adhered to:

- 1 x for steel (ST37 minimum)
- 1.25 x for cast-iron
- 2 x for aluminium
- 2.5 x for light metals

When fastening in low resistance material allow a bigger thread diameter to compensate for lower resistance. The tap used must be to current European standards and long enough to accommodate the full length of the bolt. Material developed for temperature between -20°C and +200°C:

- From -40°C to -20°C loss of 20% of WLL
- From +200°C to +300°C loss of 10% of WLL
- From +300°C to +400°C loss of 25% of WLL

Avoid using in corrosive areas or ones that contain; sand, chemical, acid, moisture... (Contact the manufacturer for stainless steel rings solution). Using swivel lifting rings with an angle generates WLL reduced coefficients. Please use the lifting angles table in the technical catalogue to calculate the coefficients. For any size not shown in the lifting angles table, please contact the technical team at Automotion Components.

## RING FASTENING

Bolts must be tightened to the correct torque as recommended in the Automotion catalogue. Ensure that the whole ring flange is in contact with the piece to be lifted. For single use without turning movements/rotation, hand tighten with wrench/allen key, until complete contact between ring base and lifted item is sufficient. Check the tightness before each use. Ensure maximum torque as recommended in the Automotion catalogue is not exceeded.

All swivelling parts must be able to move in all directions without obstruction. If using centring type rings ensure an extra hole is drilled in order to maximise bolt strength. Take the centre of gravity into account. Before lifting, ensure the shackle is correctly orientated in the direction of lifting.

## INSPECTIONS AND REPAIR

Inspection must be carried out by authorised persons who have been trained to current European standards. A visual inspection before each use is necessary. The following points must be checked:

- Thread condition
- Swivelling system
- Unusual wear and/or corrosion
- Bending
- Presence of CE markings, traceability code and WLL markings

If any of these conditions are not met, further inspection is necessary. A full inspection must be performed annually. In some cases, frequent detailed investigations are required. Automotion Components can provide control sheets on request. All swivel lifting rings manufactured by Automotion Components can be returned once a year for a free analysis.



**Web: [www.automotioncomponents.com](http://www.automotioncomponents.com)**

**Tel.: 01483 26 67 74**

**Fax: 01483 26 67 75**

**Email: [info@automotioncomponents.com](mailto:info@automotioncomponents.com)**