

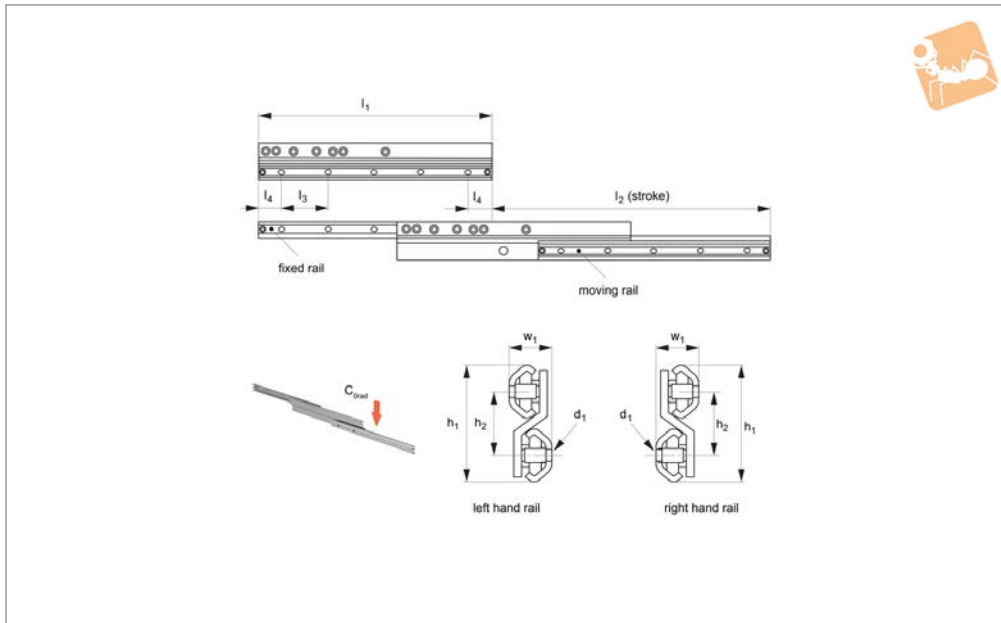

Stainless Medium Duty Full Extension

316 stainless

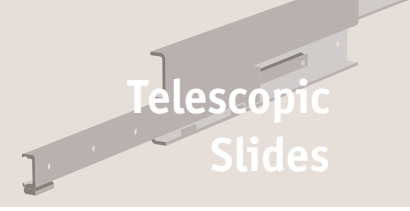

L1989

TELESCOPIC SLIDES

Material

Stainless steel (AISI 316L), bearings stainless steel (AISI 440). Bearings seals, type 2RS (splash-proof).

Technical Notes

Full stainless steel rails for washdown,

pharmaceutical, medical and other applications.
 Fixing screw - low height ISO 7380 or Torx screws on request.
 Temperature range from -30° to +100°C.

Tips

The bearings and wiper arrangement (rather than small ball bearings) provide a robust defence to dirt and other contaminants.

Order No.	Type	l_1	l_2 stroke	h_1	h_2	l_3	l_4	w_1	For screws d_1	No. of fixing holes (2 rails)	Load (per rail) $C_{0\ rad}$ N max.	Weight kg
L1989.30-0400L	Left	400	480	65,5	36	80	40	24,3	M5	10	150	1,36
L1989.30-0480L	Left	480	560	65,5	36	80	40	24,3	M5	12	200	1,63
L1989.30-0560L	Left	560	640	65,5	36	80	40	24,3	M5	14	240	1,90
L1989.30-0640L	Left	640	720	65,5	280	80	40	24,3	M5	16	280	2,18
L1989.30-0720L	Left	720	800	65,5	36	80	40	24,3	M5	18	320	2,45
L1989.30-0800L	Left	800	880	65,5	36	80	40	24,3	M5	20	360	2,72
L1989.30-0880L	Left	880	960	65,5	36	80	40	24,3	M5	22	350	2,99
L1989.30-0960L	Left	960	1040	65,5	36	80	40	24,3	M5	24	310	3,26
L1989.30-1040L	Left	1040	1120	65,5	36	80	40	24,3	M5	26	250	3,54
L1989.30-0400R	Right	400	480	65,5	36	80	40	24,3	M5	10	150	1,36
L1989.30-0480R	Right	480	560	65,5	36	80	40	24,3	M5	12	200	1,63
L1989.30-0560R	Right	560	640	65,5	36	80	40	24,3	M5	14	240	1,90
L1989.30-0640R	Right	640	720	65,5	36	80	40	24,3	M5	16	280	2,18
L1989.30-0720R	Right	720	800	65,5	36	80	40	24,3	M5	18	320	2,45
L1989.30-0800R	Right	800	880	65,5	36	80	40	24,3	M5	20	360	2,72
L1989.30-0880R	Right	880	960	65,5	36	80	40	24,3	M5	22	350	2,99
L1989.30-0960R	Right	960	1040	65,5	36	80	40	24,3	M5	24	310	3,26
L1989.30-1040R	Right	1040	1120	65,5	36	80	40	24,3	M5	26	250	3,54



If you are looking for heavy duty, quality telescopic rails for industrial or commercial applications then these are the rails for you!

The best heavy duty telescopic slides on the market

These are unique rails that are not made from pressed steel but from cold-drawn steel section. The rails can take high loads, with very long strokes, with repeated use, low deflection and minimal play.

TELESCOPIC SLIDES

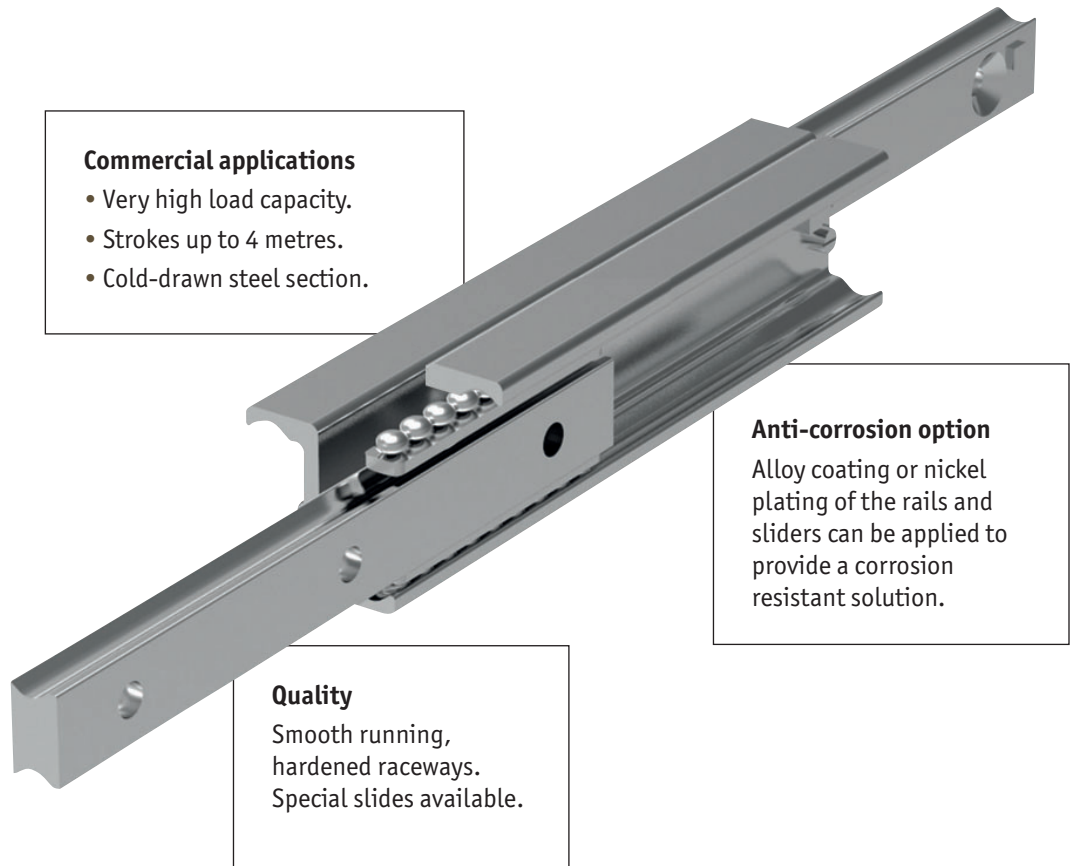

Commercial applications

- Very high load capacity.
- Strokes up to 4 metres.
- Cold-drawn steel section.

Anti-corrosion option

Alloy coating or nickel plating of the rails and sliders can be applied to provide a corrosion resistant solution.

Quality

Smooth running, hardened raceways. Special slides available.

Rail types

Our range of telescopic rails covers partial, full stroke and over-extension.

For more information refer to our product specifications pages or call our technical department.

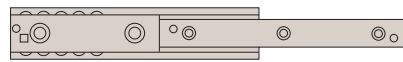

Partial Stroke (~60%)

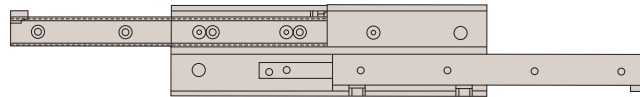

Full Stroke (~100%)

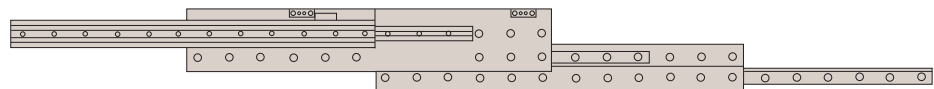

Over-extension (150%)



Telescopic Rail

Specifications and applications

Telescopic Rail

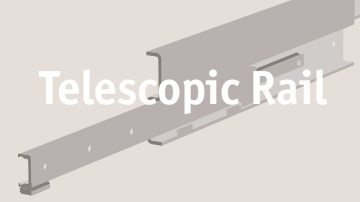

Specifications

- Generally all our telescopic rails have induction hardened raceways.
- Cold drawn roller bearing steel.
- Maximum operating speed 0,8 m/s.
- Temperature range (mainly -30°C to +170°C).
- Electrolytic galvanised to ISO 2081, other anti-corrosion finishes on request.
- High load ratings with low deflection characteristics.
- Minimum play (even at maximum load ratings).
- Smooth, free running movement.
- Long strokes and heavy load ratings.
- Can be used in horizontal applications only (due to the use of a ball cage), with the exception of part number L1985 which uses roller bearings.
- Light duty “cage stops” are included on the telescopic rails to prevent damage to the ball cage. External end stops must be designed into your application (to protect the rails from high forces and possible damage on opening and closing).
- For telescopic rails with an “upper” and “lower” rail, the moving rail should be the lower one. Using the upper rail as the moving element effects the smooth running and the load capacity of the telescopic sliders.
- All load capacity figures are given for a single rail, and based on continuous use.
- Fix to structures using screws of strength class 10,9.
- Anti-corrosion option. We have a highly effective anti-corrosive coating option, and we utilise stainless steel ball bearings in this version.

Applications



Special purpose & packaging machines

Precision positioning systems
handling units
robotic systems • cutting machines



Seating

Sliding seats
disability ramps
seat extensions



Safety guarding

Extending protective systems
sliding gates
automatic pick & place



Logistics solutions

Container extensions
heavy duty extending systems
sliding doors



Disability vehicles

Sliding seats
extension ramps



Transport (naval)

Sliding hatches
pull-out storage



Transport (rail)

Seat adjustment
sliding doors
battery removal units



Transport (automotive)

Ambulance sliding systems
fire fighting vehicles
sliding panels



Transport (military)

Sliding seats
protective hatches
stretcher extensions



L1989 - these are full extension slides made from 316L stainless steel. For use in applications where corrosion may be a problem.

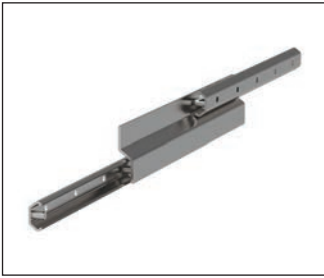

Standard extension	100%
Special extension range	No
Single & double direction?	No
Number of rail sizes	1
Maximum extension (at 100%)	1120 mm
Maximum load (per rail)	35 Kg

Extended stroke telescopic rails

L1997 - these are extended stroke (150%), heavy duty telescopic rails, with high load capacity and stiffness.

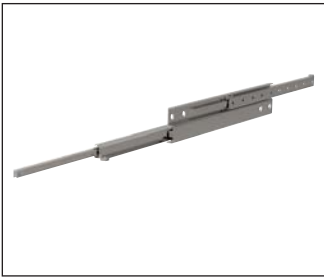

Standard extension	150%
Special extension range	On request
Single & double direction?	No
Number of rail sizes	1
Maximum extension (at 150%)	3030 mm
Maximum load (per rail)	240 Kg

L1998 - these are extended stroke (150%), heavy duty telescopic rails. They have a solid steel intermediate element. They are our heaviest duty extended stroke units.

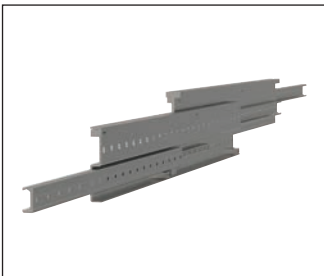

Standard extension	150%
Special extension range	On request
Single & double direction?	No
Number of rail sizes	1
Maximum extension (at 150%)	3020 mm
Maximum load (per rail)	480 Kg

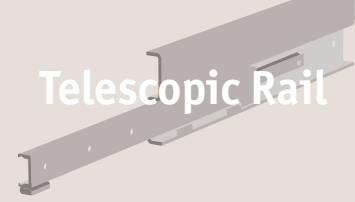

Service life

The service life is defined as the time span between commissioning and the first fatigue or wear indications on the raceway. The service life of a telescopic rail is dependent on several factors, such as the effective load, the installation precision, occurring shocks and vibrations, the operating temperature, the ambient conditions and the lubrication.

Calculation of the service life is based exclusively on the loaded rows of balls.

In practice, the decommissioning of the bearing, due to its destruction or extreme wear of a component, represents the end of service life.

This is taken into account by an application coefficient (f_i), so the service life consists of:

$$L_{Km} = 100 \cdot \left(\frac{\delta}{W} \cdot \frac{1}{f_i} \right)^3$$

L = calculated service life in Km

δ = load capacity factor in N (see tables on following pages)

W = equivalent load in N

f_i = application coefficient

Application coefficient f_i

Operating conditions	Safety factor (f_i)
Neither shocks or vibrations, smooth and low-frequency direction change, clean environment	1,3 - 1,8
Light vibrations and average direction change	1,8 - 2,3
Shocks and vibrations, high-frequency direction change, very dirty environment	2,3 - 3,5

If the external load, P , is the same as the dynamic load capacity, C_{0rad} (which of course must never be exceeded), the service life at ideal operating conditions ($f_i = 1$) is 100Km.

For a single load P , the following applies: $W = P$.

If several external loads occur simultaneously, the equivalent load is calculated as follows:

$$W = P_{rad} + \left(\frac{P_{ax}}{C_{0ax}} + \frac{M_1}{M_x} + \frac{M_2}{M_y} + \frac{M_3}{M_z} \right) \cdot C_{0rad}$$