

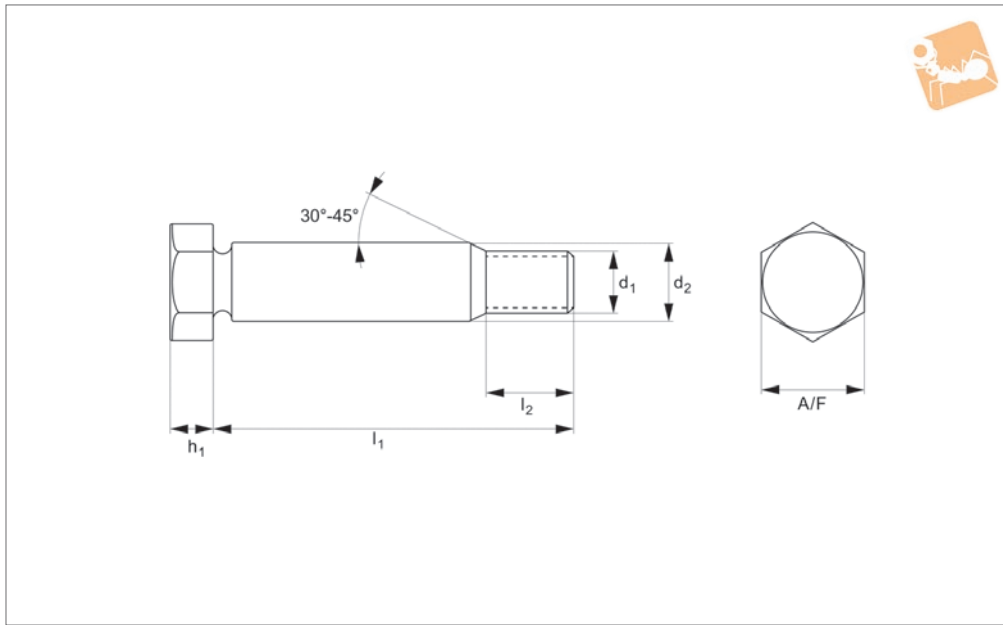

Steel Shoulder Bolts - Hex. Head

short thread, steel 8.8

Shoulder Screws



P0140.SC

SHOULDER SCREWS

Material

Black alloy steel, strength 8,8. Hardness 38 HRC, tensile strength 830 N/mm².

Technical Notes

To DIN 610. Shorter thread than P0138.SC

(DIN 609).

For strength 10,9 see part P0141.

Tips

Do not tighten to standard strength class 8,8 torque; as the tightening torque is

limited,

by the presence of the reduced diameter undercut under the head and at the shoulder/thread area.

Drill hole to H7 tolerance.

Order No.	d ₁	d ₂ tol. k6	l ₁	l ₂	h ₁	A/F
P0140.080-025-SC	M 8	9	25	11.5	5.3	13
P0140.080-028-SC	M 8	9	28	11.5	5.3	13
P0140.080-030-SC	M 8	9	30	11.5	5.3	13
P0140.080-032-SC	M 8	9	32	11.5	5.3	13
P0140.080-035-SC	M 8	9	35	11.5	5.3	13
P0140.080-038-SC	M 8	9	38	11.5	5.3	13
P0140.080-040-SC	M 8	9	40	11.5	5.3	13
P0140.080-042-SC	M 8	9	42	11.5	5.3	13
P0140.080-045-SC	M 8	9	45	11.5	5.3	13
P0140.080-048-SC	M 8	9	48	11.5	5.3	13
P0140.080-050-SC	M 8	9	50	11.5	5.3	13
P0140.080-055-SC	M 8	9	55	13.5	5.3	13
P0140.080-060-SC	M 8	9	60	13.5	5.3	13
P0140.080-065-SC	M 8	9	65	13.5	5.3	13
P0140.080-070-SC	M 8	9	70	13.5	5.3	13
P0140.080-080-SC	M 8	9	80	13.5	5.3	13
P0140.100-030-SC	M10	11	30	13.5	6.4	17
P0140.100-032-SC	M10	11	32	13.5	6.4	17
P0140.100-035-SC	M10	11	35	13.5	6.4	17
P0140.100-038-SC	M10	11	38	13.5	6.4	17
P0140.100-040-SC	M10	11	40	13.5	6.4	17
P0140.100-042-SC	M10	11	42	13.5	6.4	17
P0140.100-045-SC	M10	11	45	13.5	6.4	17
P0140.100-048-SC	M10	11	48	13.5	6.4	17
P0140.100-050-SC	M10	11	50	13.5	6.4	17
P0140.100-055-SC	M10	11	55	15.5	6.4	17
P0140.100-060-SC	M10	11	60	15.5	6.4	17
P0140.100-065-SC	M10	11	65	15.5	6.4	17
P0140.100-070-SC	M10	11	70	15.5	6.4	17
P0140.100-075-SC	M10	11	75	15.5	6.4	17
P0140.100-080-SC	M10	11	80	15.5	6.4	17
P0140.100-085-SC	M10	11	85	15.5	6.4	17

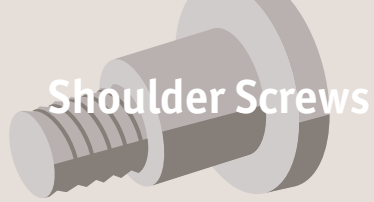

Shoulder Screws

Steel Shoulder Bolts - Hex. Head

short thread, steel 8.8



SHOULDER SCREWS

Order No.	d ₁	d ₂ tol. k6	l ₁	l ₂	h ₁	A/F
P0140.100-090-SC	M10	11	90	15.5	6.4	17
P0140.100-100-SC	M10	11	100	15.5	6.4	17
P0140.100-110-SC	M10	11	110	15.5	6.4	17
P0140.100-120-SC	M10	11	120	15.5	6.4	17
P0140.120-030-SC	M12	13	30	15.5	7.5	19
P0140.120-032-SC	M12	13	32	15.5	7.5	19
P0140.120-035-SC	M12	13	35	15.5	7.5	19
P0140.120-038-SC	M12	13	38	15.5	7.5	19
P0140.120-040-SC	M12	13	40	15.5	7.5	19
P0140.120-042-SC	M12	13	42	15.5	7.5	19
P0140.120-045-SC	M12	13	45	15.5	7.5	19
P0140.120-048-SC	M12	13	48	15.5	7.5	19
P0140.120-050-SC	M12	13	50	15.5	7.5	19
P0140.120-055-SC	M12	13	55	17.5	7.5	19
P0140.120-060-SC	M12	13	60	17.5	7.5	19
P0140.120-065-SC	M12	13	65	17.5	7.5	19
P0140.120-070-SC	M12	13	70	17.5	7.5	19
P0140.120-075-SC	M12	13	75	17.5	7.5	19
P0140.120-080-SC	M12	13	80	17.5	7.5	19
P0140.120-085-SC	M12	13	85	17.5	7.5	19
P0140.120-090-SC	M12	13	90	17.5	7.5	19
P0140.120-095-SC	M12	13	95	17.5	7.5	19
P0140.120-100-SC	M12	13	100	17.5	7.5	19
P0140.140-032-SC	M14	15	32	17.0	8.8	22
P0140.140-035-SC	M14	15	35	17.0	8.8	22
P0140.140-040-SC	M14	15	40	17.0	8.8	22
P0140.140-042-SC	M14	15	42	17.0	8.8	22
P0140.140-045-SC	M14	15	45	17.0	8.8	22
P0140.140-050-SC	M14	15	50	17.0	8.8	22
P0140.140-055-SC	M14	15	55	19.0	8.8	22
P0140.140-060-SC	M14	15	60	19.0	8.8	22
P0140.140-065-SC	M14	15	65	19.0	8.8	22
P0140.140-070-SC	M14	15	70	19.0	8.8	22
P0140.140-075-SC	M14	15	75	19.0	8.8	22
P0140.140-080-SC	M14	15	80	19.0	8.8	22
P0140.140-090-SC	M14	15	90	19.0	8.8	22
P0140.160-040-SC	M16	17	40	19.0	10	24
P0140.160-042-SC	M16	17	42	19.0	10	24
P0140.160-045-SC	M16	17	45	19.0	10	24
P0140.160-048-SC	M16	17	48	19.0	10	24
P0140.160-050-SC	M16	17	50	19.0	10	24
P0140.160-055-SC	M16	17	55	21.0	10	24
P0140.160-060-SC	M16	17	60	21.0	10	24
P0140.160-065-SC	M16	17	65	21.0	10	24
P0140.160-070-SC	M16	17	70	21.0	10	24
P0140.160-075-SC	M16	17	75	21.0	10	24
P0140.160-080-SC	M16	17	80	21.0	10	24
P0140.160-085-SC	M16	17	85	21.0	10	24
P0140.160-090-SC	M16	17	90	21.0	10	24
P0140.160-095-SC	M16	17	95	21.0	10	24
P0140.160-100-SC	M16	17	100	21.0	10	24
P0140.160-105-SC	M16	17	105	21.0	10	24
P0140.160-110-SC	M16	17	110	21.0	10	24
P0140.160-115-SC	M16	17	115	21.0	10	24
P0140.160-120-SC	M16	17	120	21.0	10	24
P0140.160-125-SC	M16	17	125	21.0	10	24
P0140.160-130-SC	M16	17	130	21.0	10	24
P0140.160-135-SC	M16	17	135	21.0	10	24
P0140.160-140-SC	M16	17	140	21.0	10	24
P0140.160-150-SC	M16	17	150	21.0	10	24
P0140.160-160-SC	M16	17	160	26.0	10	24
P0140.160-180-SC	M16	17	180	26.0	10	24
P0140.160-200-SC	M16	17	200	26.0	10	24
P0140.180-045-SC	M18	19	45	21.5	11.5	27
P0140.180-050-SC	M18	19	50	21.5	11.5	27
P0140.180-055-SC	M18	19	55	23.5	11.5	27
P0140.180-060-SC	M18	19	60	23.5	11.5	27
P0140.180-065-SC	M18	19	65	23.5	11.5	27



Steel Shoulder Bolts - Hex. Head

short thread, steel 8.8

Shoulder Screws



Order No.	d ₁	d ₂ tol. k6	l ₁	l ₂	h ₁	A/F
P0140.180-070-SC	M18	19	70	23.5	11.5	27
P0140.180-075-SC	M18	19	75	23.5	11.5	27
P0140.180-080-SC	M18	19	80	23.5	11.5	27
P0140.180-085-SC	M18	19	85	23.5	11.5	27
P0140.180-090-SC	M18	19	90	23.5	11.5	27
P0140.180-095-SC	M18	19	95	23.5	11.5	27
P0140.180-100-SC	M18	19	100	23.5	11.5	27
P0140.180-110-SC	M18	19	110	23.5	11.5	27
P0140.180-120-SC	M18	19	120	23.5	11.5	27
P0140.200-045-SC	M20	21	45	22.5	12.5	30
P0140.200-050-SC	M20	21	50	22.5	12.5	30
P0140.200-055-SC	M20	21	55	24.5	12.5	30
P0140.200-060-SC	M20	21	60	24.5	12.5	30
P0140.200-065-SC	M20	21	65	24.5	12.5	30
P0140.200-070-SC	M20	21	70	24.5	12.5	30
P0140.200-075-SC	M20	21	75	24.5	12.5	30
P0140.200-080-SC	M20	21	80	24.5	12.5	30
P0140.200-085-SC	M20	21	85	24.5	12.5	30
P0140.200-090-SC	M20	21	90	24.5	12.5	30
P0140.200-095-SC	M20	21	95	24.5	12.5	30
P0140.200-100-SC	M20	21	100	24.5	12.5	30
P0140.200-105-SC	M20	21	105	24.5	12.5	30
P0140.200-110-SC	M20	21	110	24.5	12.5	30
P0140.200-115-SC	M20	21	115	24.5	12.5	30
P0140.200-120-SC	M20	21	120	24.5	12.5	30
P0140.200-125-SC	M20	21	125	24.5	12.5	30
P0140.200-130-SC	M20	21	130	24.5	12.5	30
P0140.200-135-SC	M20	21	135	24.5	12.5	30
P0140.200-140-SC	M20	21	140	24.5	12.5	30
P0140.200-145-SC	M20	21	145	24.5	12.5	30
P0140.200-150-SC	M20	21	150	24.5	12.5	30
P0140.200-160-SC	M20	21	160	29.5	12.5	30
P0140.200-170-SC	M20	21	170	29.5	12.5	30
P0140.200-180-SC	M20	21	180	29.5	12.5	30
P0140.200-185-SC	M20	21	185	29.5	12.5	30
P0140.200-190-SC	M20	21	190	29.5	12.5	30
P0140.200-200-SC	M20	21	200	29.5	12.5	30
P0140.200-220-SC	M20	21	220	29.5	12.5	30
P0140.200-240-SC	M20	21	240	29.5	12.5	30
P0140.201-045-SC	M20x2	21	45	22.5	12.5	30
P0140.201-050-SC	M20x2	21	50	22.5	12.5	30
P0140.201-055-SC	M20x2	21	55	24.5	12.5	30
P0140.201-060-SC	M20x2	21	60	24.5	12.5	30
P0140.201-065-SC	M20x2	21	65	24.5	12.5	30
P0140.201-070-SC	M20x2	21	70	24.5	12.5	30
P0140.201-075-SC	M20x2	21	75	24.5	12.5	30
P0140.201-080-SC	M20x2	21	80	24.5	12.5	30
P0140.201-085-SC	M20x2	21	85	24.5	12.5	30
P0140.201-090-SC	M20x2	21	90	24.5	12.5	30
P0140.201-095-SC	M20x2	21	95	24.5	12.5	30
P0140.201-100-SC	M20x2	21	100	24.5	12.5	30
P0140.201-105-SC	M20x2	21	105	24.5	12.5	30
P0140.201-110-SC	M20x2	21	110	24.5	12.5	30
P0140.201-120-SC	M20x2	21	120	24.5	12.5	30
P0140.201-130-SC	M20x2	21	130	24.5	12.5	30
P0140.201-135-SC	M20x2	21	135	24.5	12.5	30
P0140.201-140-SC	M20x2	21	140	24.5	12.5	30
P0140.201-145-SC	M20x2	21	145	24.5	12.5	30
P0140.201-160-SC	M20x2	21	160	29.5	12.5	30
P0140.201-180-SC	M20x2	21	180	29.5	12.5	30
P0140.220-045-SC	M22	23	45	24.5	14.0	34
P0140.220-050-SC	M22	23	50	24.5	14.0	34
P0140.220-055-SC	M22	23	55	26.5	14.0	34
P0140.220-060-SC	M22	23	60	26.5	14.0	34
P0140.220-065-SC	M22	23	65	26.5	14.0	34
P0140.220-070-SC	M22	23	70	26.5	14.0	34
P0140.220-075-SC	M22	23	75	26.5	14.0	34
P0140.220-080-SC	M22	23	80	26.5	14.0	34

SHOULDER SCREWS

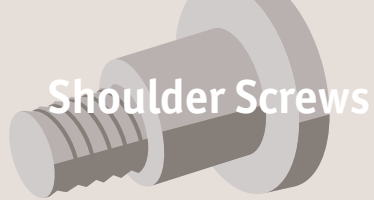

Shoulder Screws

Steel Shoulder Bolts - Hex. Head

short thread, steel 8.8

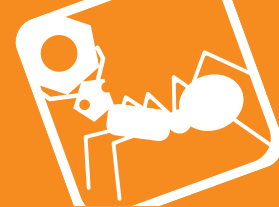

SHOULDER SCREWS

Order No.	d ₁	d ₂ tol. k6	l ₁	l ₂	h ₁	A/F
P0140.220-085-SC	M22	23	85	26.5	14.0	34
P0140.220-090-SC	M22	23	90	26.5	14.0	34
P0140.220-095-SC	M22	23	95	26.5	14.0	34
P0140.220-100-SC	M22	23	100	26.5	14.0	34
P0140.220-105-SC	M22	23	105	26.5	14.0	34
P0140.220-110-SC	M22	23	110	26.5	14.0	34
P0140.220-120-SC	M22	23	120	26.5	14.0	34
P0140.220-130-SC	M22	23	130	26.5	14.0	34
P0140.220-140-SC	M22	23	140	26.5	14.0	34
P0140.220-150-SC	M22	23	150	26.5	14.0	34
P0140.220-180-SC	M22	23	180	31.5	14.0	34
P0140.240-055-SC	M24	25	55	28.5	15.0	36
P0140.240-060-SC	M24	25	60	28.5	15.0	36
P0140.240-065-SC	M24	25	65	28.5	15.0	36
P0140.240-070-SC	M24	25	70	28.5	15.0	36
P0140.240-075-SC	M24	25	75	28.5	15.0	36
P0140.240-080-SC	M24	25	80	28.5	15.0	36
P0140.240-085-SC	M24	25	85	28.5	15.0	36
P0140.240-090-SC	M24	25	90	28.5	15.0	36
P0140.240-095-SC	M24	25	95	28.5	15.0	36
P0140.240-100-SC	M24	25	100	28.5	15.0	36
P0140.240-105-SC	M24	25	105	28.5	15.0	36
P0140.240-110-SC	M24	25	110	28.5	15.0	36
P0140.240-115-SC	M24	25	115	28.5	15.0	36
P0140.240-120-SC	M24	25	120	28.5	15.0	36
P0140.240-125-SC	M24	25	125	28.5	15.0	36
P0140.240-130-SC	M24	25	130	28.5	15.0	36
P0140.240-135-SC	M24	25	135	28.5	15.0	36
P0140.240-140-SC	M24	25	140	28.5	15.0	36
P0140.240-145-SC	M24	25	145	28.5	15.0	36
P0140.240-150-SC	M24	25	150	28.5	15.0	36
P0140.240-160-SC	M24	25	160	33.5	15.0	36
P0140.240-170-SC	M24	25	170	33.5	15.0	36
P0140.240-180-SC	M24	25	180	33.5	15.0	36
P0140.240-185-SC	M24	25	185	33.5	15.0	36
P0140.240-190-SC	M24	25	190	33.5	15.0	36
P0140.240-200-SC	M24	25	200	33.5	15.0	36
P0140.240-220-SC	M24	25	220	33.5	15.0	36
P0140.240-240-SC	M24	25	240	33.5	15.0	36
P0140.241-055-SC	M24x2	25	55	28.5	15.0	36
P0140.241-060-SC	M24x2	25	60	28.5	15.0	36
P0140.241-065-SC	M24x2	25	65	28.5	15.0	36
P0140.241-070-SC	M24x2	25	70	28.5	15.0	36
P0140.241-075-SC	M24x2	25	75	28.5	15.0	36
P0140.241-080-SC	M24x2	25	80	28.5	15.0	36
P0140.241-085-SC	M24x2	25	85	28.5	15.0	36
P0140.241-090-SC	M24x2	25	90	28.5	15.0	36
P0140.241-095-SC	M24x2	25	95	28.5	15.0	36
P0140.241-100-SC	M24x2	25	100	28.5	15.0	36
P0140.241-105-SC	M24x2	25	105	28.5	15.0	36
P0140.241-110-SC	M24x2	25	110	28.5	15.0	36
P0140.241-115-SC	M24x2	25	115	28.5	15.0	36
P0140.241-120-SC	M24x2	25	120	28.5	15.0	36
P0140.241-130-SC	M24x2	25	130	28.5	15.0	36
P0140.241-135-SC	M24x2	25	135	28.5	15.0	36
P0140.241-140-SC	M24x2	25	140	28.5	15.0	36
P0140.241-150-SC	M24x2	25	150	28.5	15.0	36
P0140.270-060-SC	M27	28	60	31.5	17.0	41
P0140.270-065-SC	M27	28	65	31.5	17.0	41
P0140.270-070-SC	M27	28	70	31.5	17.0	41
P0140.270-075-SC	M27	28	75	31.5	17.0	41
P0140.270-080-SC	M27	28	80	31.5	17.0	41
P0140.270-085-SC	M27	28	85	31.5	17.0	41
P0140.270-090-SC	M27	28	90	31.5	17.0	41
P0140.270-095-SC	M27	28	95	31.5	17.0	41
P0140.270-100-SC	M27	28	100	31.5	17.0	41
P0140.270-105-SC	M27	28	105	31.5	17.0	41
P0140.270-110-SC	M27	28	110	31.5	17.0	41



Steel Shoulder Bolts - Hex. Head

short thread, steel 8.8

Shoulder Screws



Order No.	d ₁	d ₂ tol. k6	l ₁	l ₂	h ₁	A/F
P0140.270-115-SC	M27	28	115	31.5	17.0	41
P0140.270-120-SC	M27	28	120	31.5	17.0	41
P0140.270-125-SC	M27	28	125	31.5	17.0	41
P0140.270-130-SC	M27	28	130	31.5	17.0	41
P0140.270-135-SC	M27	28	135	31.5	17.0	41
P0140.270-140-SC	M27	28	140	31.5	17.0	41
P0140.270-145-SC	M27	28	145	31.5	17.0	41
P0140.270-150-SC	M27	28	150	31.5	17.0	41
P0140.270-160-SC	M27	28	160	36.5	17.0	41
P0140.270-170-SC	M27	28	170	36.5	17.0	41
P0140.270-180-SC	M27	28	180	36.5	17.0	41
P0140.270-200-SC	M27	28	200	36.5	17.0	41
P0140.300-065-SC	M30	32	65	34.0	19.0	46
P0140.300-070-SC	M30	32	70	34.0	19.0	46
P0140.300-075-SC	M30	32	75	34.0	19.0	46
P0140.300-080-SC	M30	32	80	34.0	19.0	46
P0140.300-085-SC	M30	32	85	34.0	19.0	46
P0140.300-090-SC	M30	32	90	34.0	19.0	46
P0140.300-100-SC	M30	32	100	34.0	19.0	46
P0140.300-105-SC	M30	32	105	34.0	19.0	46
P0140.300-110-SC	M30	32	110	34.0	19.0	46
P0140.300-115-SC	M30	32	115	34.0	19.0	46
P0140.300-120-SC	M30	32	120	34.0	19.0	46
P0140.300-125-SC	M30	32	125	34.0	19.0	46
P0140.300-130-SC	M30	32	130	34.0	19.0	46
P0140.300-135-SC	M30	32	135	34.0	19.0	46
P0140.300-140-SC	M30	32	140	34.0	19.0	46
P0140.300-145-SC	M30	32	145	34.0	19.0	46
P0140.300-150-SC	M30	32	150	34.0	19.0	46
P0140.300-160-SC	M30	32	160	39.0	19.0	46
P0140.300-170-SC	M30	32	170	39.0	19.0	46
P0140.300-180-SC	M30	32	180	39.0	19.0	46
P0140.300-185-SC	M30	32	185	39.0	19.0	46
P0140.300-190-SC	M30	32	190	39.0	19.0	46
P0140.300-200-SC	M30	32	200	39.0	19.0	46
P0140.301-065-SC	M30x2	32	65	34.0	19.0	46
P0140.301-080-SC	M30x2	32	80	34.0	19.0	46
P0140.301-085-SC	M30x2	32	85	34.0	19.0	46
P0140.301-090-SC	M30x2	32	90	34.0	19.0	46
P0140.301-095-SC	M30x2	32	95	34.0	19.0	46
P0140.301-100-SC	M30x2	32	100	34.0	19.0	46
P0140.301-105-SC	M30x2	32	105	34.0	19.0	46
P0140.301-110-SC	M30x2	32	110	34.0	19.0	46
P0140.301-115-SC	M30x2	32	115	34.0	19.0	46
P0140.301-125-SC	M30x2	32	125	34.0	19.0	46
P0140.301-130-SC	M30x2	32	130	34.0	19.0	46
P0140.301-140-SC	M30x2	32	140	34.0	19.0	46
P0140.301-150-SC	M30x2	32	150	34.0	19.0	46
P0140.301-170-SC	M30x2	32	170	39.0	19.0	46
P0140.301-180-SC	M30x2	32	180	39.0	19.0	46
P0140.301-185-SC	M30x2	32	185	39.0	19.0	46
P0140.301-190-SC	M30x2	32	190	39.0	19.0	46
P0140.360-070-SC	M36	38	70	40.0	22.0	55
P0140.360-075-SC	M36	38	75	40.0	22.0	55
P0140.360-080-SC	M36	38	80	40.0	22.0	55
P0140.360-085-SC	M36	38	85	40.0	22.0	55
P0140.360-090-SC	M36	38	90	40.0	22.0	55
P0140.360-095-SC	M36	38	95	40.0	22.0	55
P0140.360-100-SC	M36	38	100	40.0	22.0	55
P0140.360-105-SC	M36	38	105	40.0	22.0	55
P0140.360-110-SC	M36	38	110	40.0	22.0	55
P0140.360-115-SC	M36	38	115	40.0	22.0	55
P0140.360-120-SC	M36	38	120	40.0	22.0	55
P0140.360-125-SC	M36	38	125	40.0	22.0	55
P0140.360-130-SC	M36	38	130	40.0	22.0	55
P0140.360-135-SC	M36	38	135	40.0	22.0	55
P0140.360-140-SC	M36	38	140	40.0	22.0	55
P0140.360-145-SC	M36	38	145	40.0	22.0	55

SHOULDER SCREWS

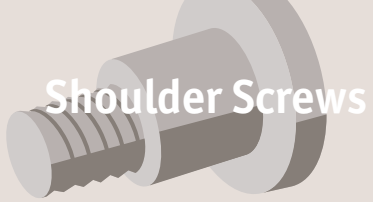

Shoulder Screws

Steel Shoulder Bolts - Hex. Head short thread, steel 8.8



SHOULDER SCREWS

Order No.	d ₁	d ₂ tol. k6	l ₁	l ₂	h ₁	A/F
P0140.360-150-SC	M36	38	150	40.0	22.0	55
P0140.360-160-SC	M36	38	160	45.0	22.0	55
P0140.360-170-SC	M36	38	170	45.0	22.0	55
P0140.360-180-SC	M36	38	180	45.0	22.0	55
P0140.360-185-SC	M36	38	185	45.0	22.0	55
P0140.360-190-SC	M36	38	190	45.0	22.0	55
P0140.360-200-SC	M36	38	200	45.0	22.0	55
P0140.390-160-SC	M39	40	160	47.0	25.0	60
P0140.390-320-SC	M39	40	320	47.0	25.0	60
P0140.420-100-SC	M42	44	100	46.0	26.0	65
P0140.420-110-SC	M42	44	110	46.0	26.0	65
P0140.420-120-SC	M42	44	120	46.0	26.0	65
P0140.420-130-SC	M42	44	130	46.0	26.0	65
P0140.420-140-SC	M42	44	140	46.0	26.0	65
P0140.420-150-SC	M42	44	150	46.0	26.0	65
P0140.420-160-SC	M42	44	160	51.0	26.0	65
P0140.420-170-SC	M42	44	170	51.0	26.0	65
P0140.420-180-SC	M42	44	180	51.0	26.0	65
P0140.420-185-SC	M42	44	185	51.0	26.0	65
P0140.420-190-SC	M42	44	190	51.0	26.0	65
P0140.420-200-SC	M42	44	200	51.0	26.0	65
P0140.420-240-SC	M42	44	240	51.0	26.0	65
P0140.420-280-SC	M42	44	280	51.0	26.0	65
P0140.420-370-SC	M42	44	370	51.0	26.0	65



Product Overview

Shoulder Screws & Shoulder Bolts

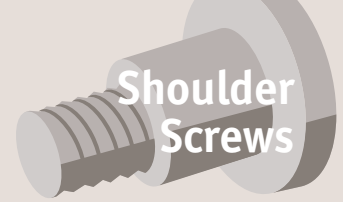

SHOULDER SCREWS

Steel shoulder screws

These are our least expensive option. They are produced to ISO 7379 standards.

Thread sizes from Ø4 M3 to Ø24 M20. We manufacture special shoulder screws to customer drawings with a minimum batch size.



Stainless steel shoulder screws

We have three different grades of stainless steel shoulder screws:

303 series – these are our standard grade of stainless (P0130.A2). They are strong and resistant to corrosion but not to very harsh environments such as salt water.



416 series – these are made from harder stainless steel with improved shear strengths but the parts are more prone to corrosion (see part no. P0131 and P0133).

316 series – these shoulder screws (P0130.A4) are very resistant to corrosion but are considerably more expensive than other stainless versions.



Shoulder bolts

Our range of precision shoulder bolts with hexagonal heads come in both steel (grades 8.8 and 10.9) and stainless steel (303 and 316 stainless). These bolts are manufactured to DIN 609 and DIN 610. We also have shoulder bolts for construction, manufactured to DIN 7968.

	DIN 609 standard length thread	DIN 610 short length thread	DIN 7968 construction thread
Grade 8.8 steel 	P0138.SC	P0140.SC	P0142
Grade 10.9 steel 	P0139	P0141	-
303 stainless steel 	P0138.A2	P0140.A2	-

ov-shoulder-screws-product-overview-a-rmh - Updated 17-02-2023



Shoulder Screw from Automation Components

Part No.		Material	Head	Corrosion resistance	Strength	Ø/thread	DIN/ISO
P0130		303 stainless steel	Hex socket	✓✓	✓	Min: Ø4/M3 Max: Ø20/M16	-
P0130.A4		316 stainless steel	Hex socket	✓✓✓	✓	Min: Ø4/M3 Max: Ø20/M16	ISO 7379
P0131		416 stainless steel	Hex socket	✓	✓✓	Min: Ø4/M3 Max: Ø12/M10	-
P0132		303 stainless steel	Slotted	✓✓	✓	Min: Ø4/M3 Max: Ø12/M10	-
P0133		416 stainless steel	Slotted	✓	✓✓	Min: Ø4/M3 Max: Ø12/M10	-
P0134		303 stainless steel	Hex socket	✓✓	✓	Min: Ø4/M3 Max: Ø8/M6	-
P0135		303 stainless steel	Hex head	✓✓	✓	Min: Ø4/M3 Max: Ø12/M10	-
P0136		Steel 12,9	Hex socket	✗	✓✓	Min: Ø4/M3 Max: Ø24/M20	ISO 7379
P0137		304 stainless steel	Hex socket	✓✓	✓	Min: Ø6/M5 Max: Ø20/M16	ISO 7379
P0138		Steel 8,8	Hex head (long thread)	✗	✓	Min: Ø9/M8 Max: Ø44/M42	DIN 610
P0139		Steel 10,9	Hex head (long thread)	✗	✓✓	Min: Ø9/M8 Max: Ø38/M36	DIN 610
P0140		Steel 8,8	Hex socket (short thread)	✗	✓✓	Min: Ø9/M8 Max: Ø44/M42	DIN 609
P0141		Steel 10,9	Hex socket (short thread)	✗	✓✓	Min: Ø9/M8 Max: Ø38/M36	DIN 609
P0142		Steel 8,8	Hex head	✗	✓✓	Min: Ø12/M12 Max: Ø27/M27	DIN 7968
P0144		303 stainless steel	Pan head	✓✓	✓✓	Min: Ø4/M3 Max: Ø10/M8	DIN 923